



INDICATIVE PHOTO

General features : RCS1250406

RCS range unit coolers have been designed to be installed inside cold rooms suited for fresh and frozen goods storage

Their shape, being extremely compact, make their installation possible also in cold rooms having very small dimensions

RCS range is available in different combinations of fin spacing dimensions and tube rows properly sized according to the needed applications.

The ED version is supplied with mounted defrosting heaters and is suitable for being used at low temperature applications.

The fan motors operate in the suction mode and prevent the condensate forming on the fan

The coil is made of aluminium fins, 12 mm copper tube and a geometry of 37,5 x 32,5

RCS unit coolers can be classified in three groups according to the needed cold room temperature (Tc): 4mm fin spacing for a Tc from -5°C to +15°C; 6mm fin spacing for a Tc from -20°C to +15°C; 8mm fin spacing for a Tc from -40°C to +4°C

Each fin spacing group is also available with 4 and 6 rows.

The coils are tested with nitrogen at a pressure of 25 bar.

The fan motor models in use have the following features:

Manufactured following EN 60335-1 laws, with internal thermal protection

Fan diameter 250mm

Power supply 230-240V/1/50-60Hz

IP44 protection rate

F insulation class

Operating temperature from -40°C to +40°C

Electrics made in conformity with 2006/95/CE Low Tension directive

The housing is made of aluminium

The manufacturing solutions used give the housing strength and guarantee the absence of vibrations during the functioning.

Screws, washers and nuts are made of stainless steel



INDICATIVE PHOTO

Product file : Unit coolers

Code	RCS1250406ED
Model	Ceiling cubic unit cooler
Range	RCS
Application	MBP
Net weight	13,9 kg
Inlet connection	12 mm-1/2" SAE
Outlet connection	12 mm
Drain connection	1" Gas (33mm)
Ped	0
Rows	4
Fin spacing	6
Circuit volume	1,72 dm ³
Total surface	4,9 m ²

Fan motor

Type	AC
Fans no.	1
Diameter	254 mm
Power supply	230/1/50
Defrost	750 W
Speed	1300 rpm
Power consumption	80 W
Current consumption	0,35 A
Air flow	917 m ³ /h
Air throw	8 m

Technical drawing - RCS1250406

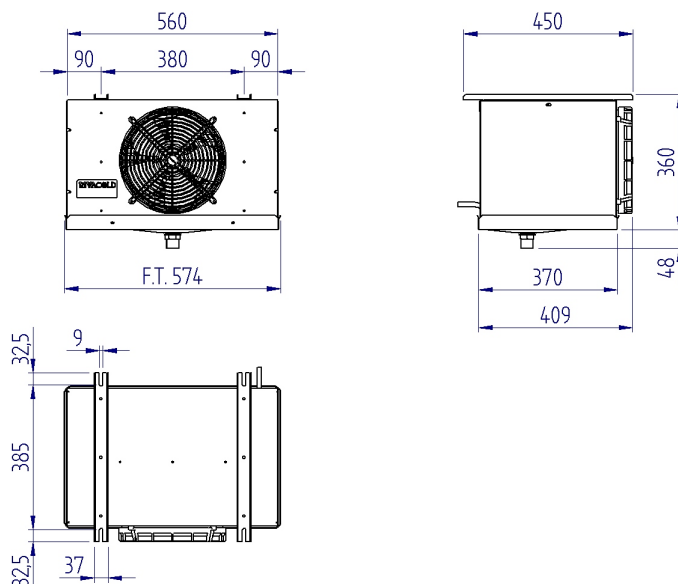

Refrigerating capacity table (watt) - Gas :

dT \ Tc	-20°C	-15°C	-10°C	-5°C	0°C	2°C	4°C	6°C	8°C	10°C	12°C	15°C
10	1150 ⁽¹⁾	1230	1300	1380	1460	1470	1480	1500	1510	1520	1560	1620
9	1040 ⁽¹⁾	1110	1170	1230	1300	1310	1320	1330	1350	1370	1390	1420
8	920 ⁽¹⁾	970	1020	1080	1140	1150	1160	1170	1180	1190	1220	1265
7	790 ⁽¹⁾	830	870	920	970	975	980	990	1000	1020	1030	1045
6	660 ⁽¹⁾	690	730	760	810	815	820	830	840	860	880	910
5	526 ⁽¹⁾	548	575	607	649	655	660	667	682	699	718	746

(1) Applicazione fuori dal campo consigliato